

Art.no 481-67

FIRST USE

STEP 1.

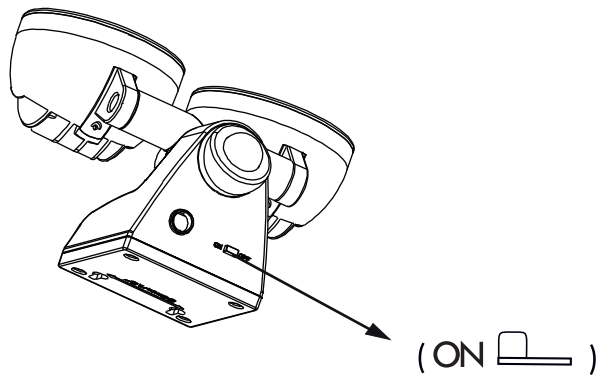

STEP 2.

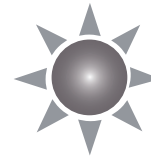

(ON )

(OFF )

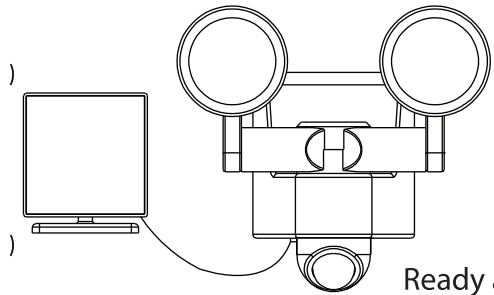

Ready after
36 h in the sun

BATTERY REPLACEMENT

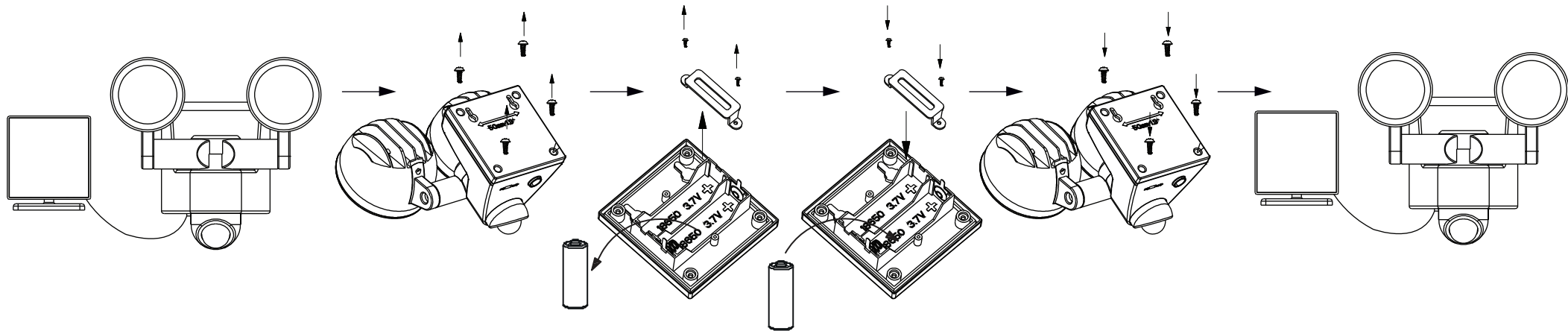

STAR[®]
TRADING
STAR STREET 1
512 50 SVENLJUNGA
SWEDEN
www.startrading.com

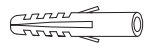

x 4



x 4

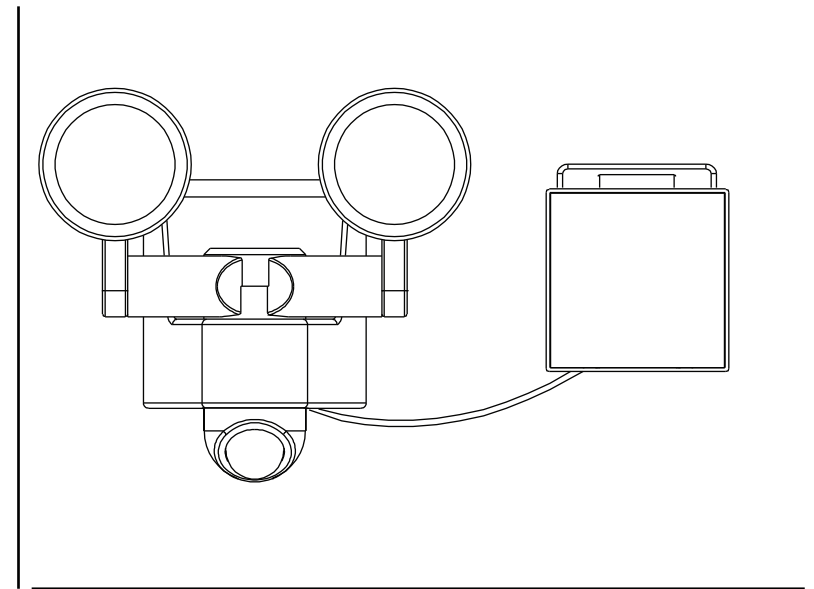
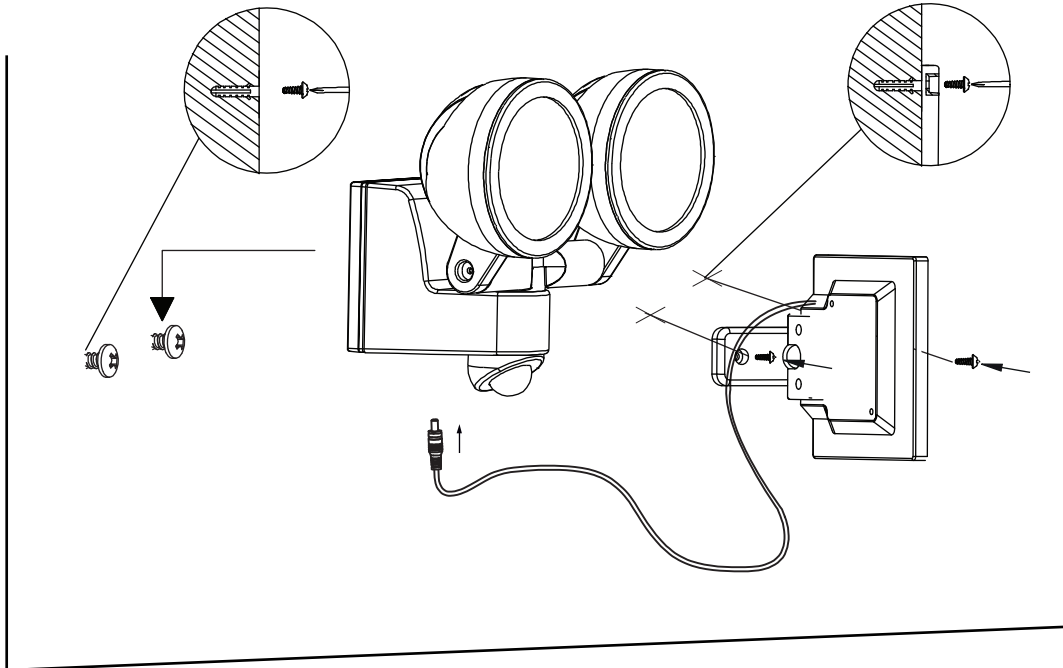
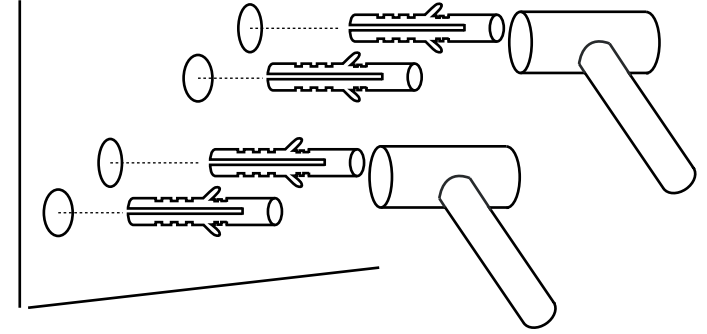
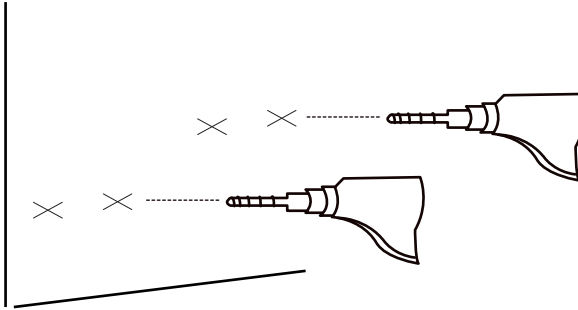
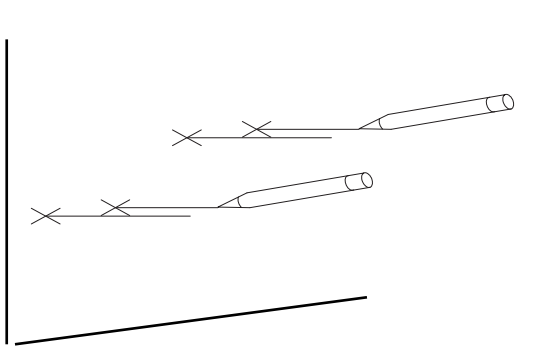

Art No: 481-67

15 LUMEN CONSTANT LIGHT

MOTION SENSOR 350 LUMEN FOR 60 SEK

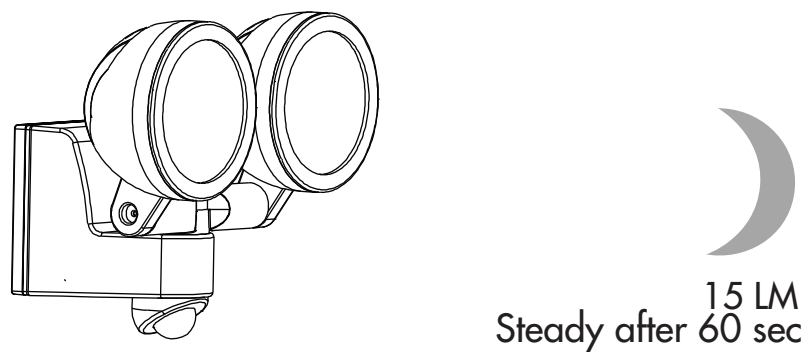
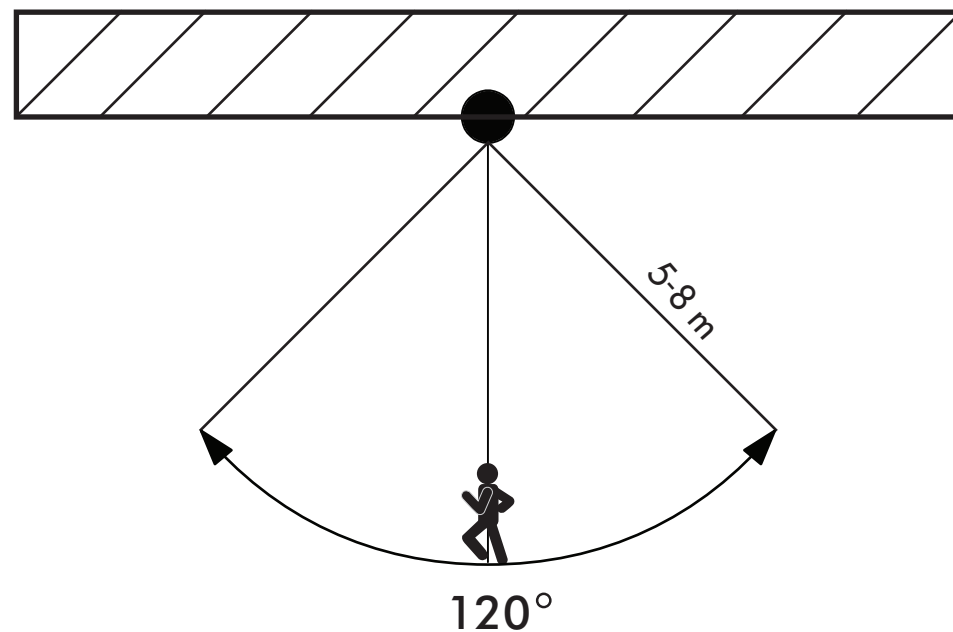
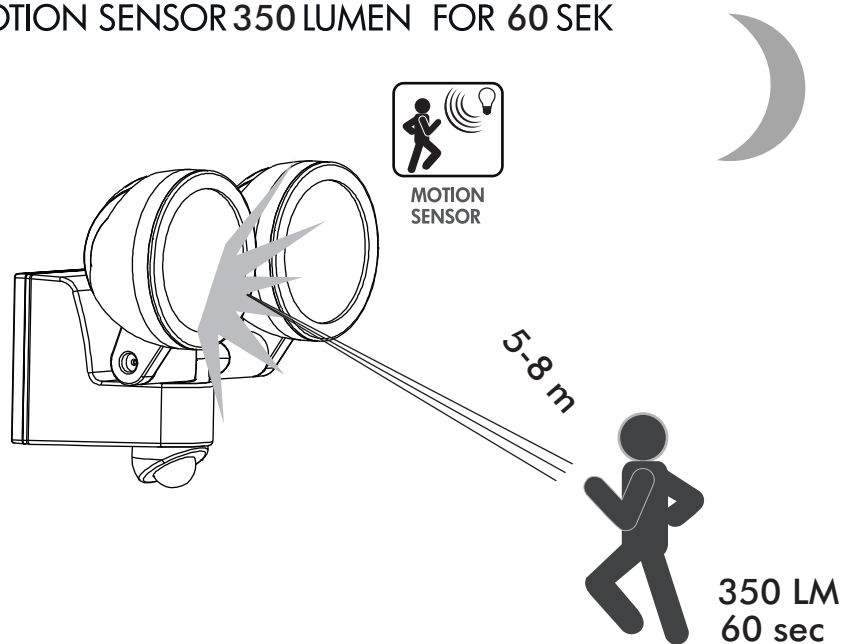

STAR[®]
TRADING
STAR STREET 1
512 50 SVENLJUNGA
SWEDEN
www.startrading.com