

**Art.no 480-89**  
**FIRST USE**

**STEP 1.**

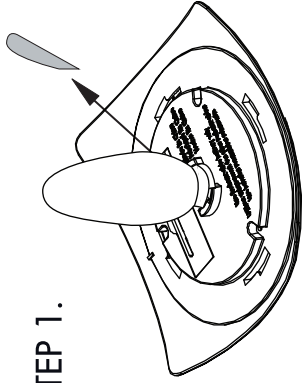

**STEP 2.**

Ready after  
36 h in the sun

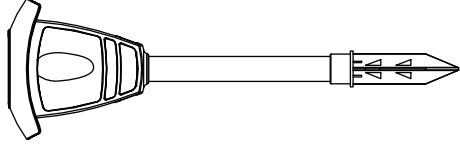

**BATTERY REPLACEMENT**

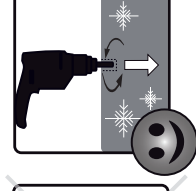
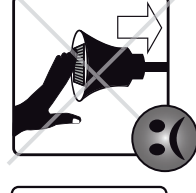
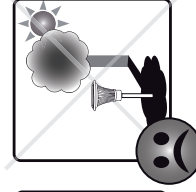
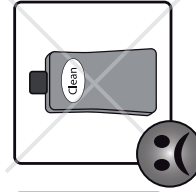
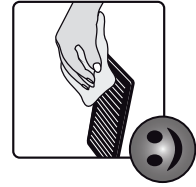
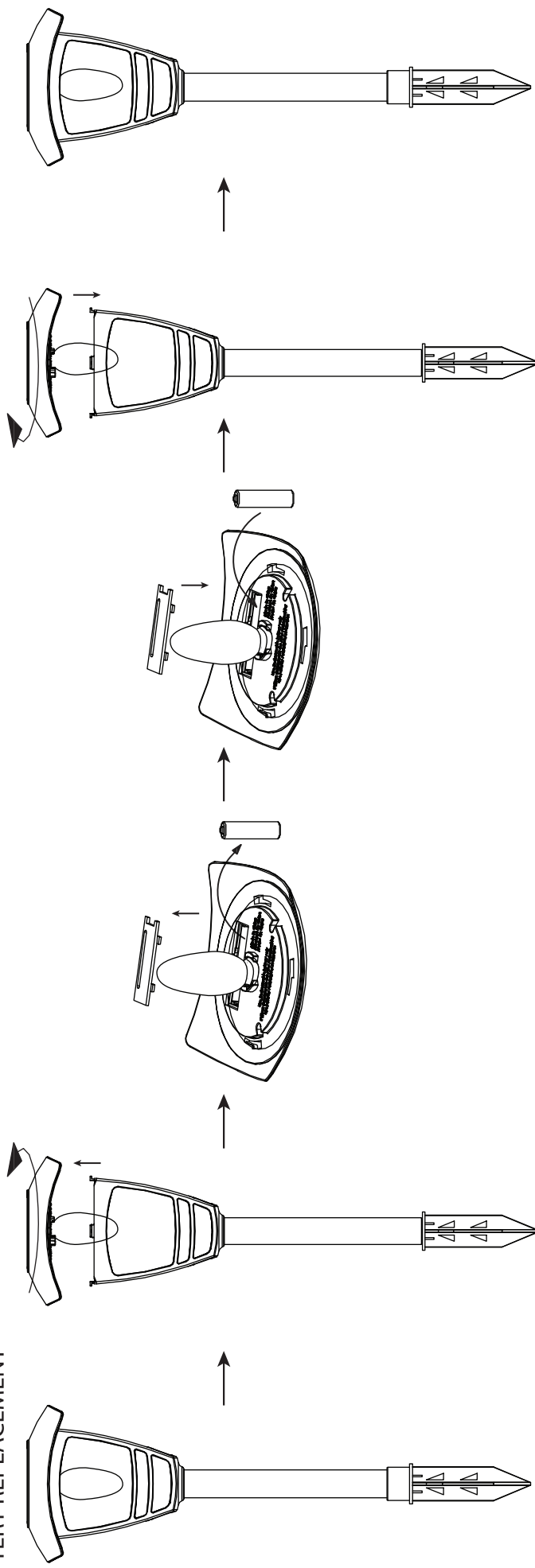

**STAR**  
TRADING  
STAR STREET 1  
512 50 SVENLJUNGA  
SWEDEN  
[www.starttrading.com](http://www.starttrading.com)