

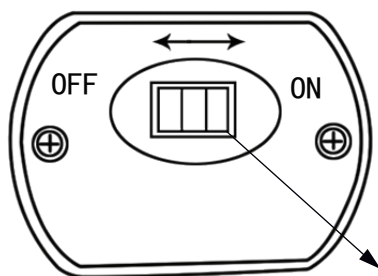

Art.no 481-99-47

FIRST USE

STEP 1.



(ON )

STEP 2.

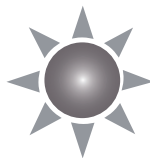

(ON )



(OFF )

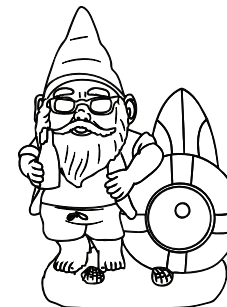

Ready after
36 h in the sun

BATTERY REPLACEMENT

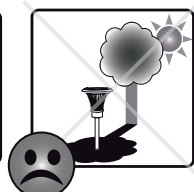
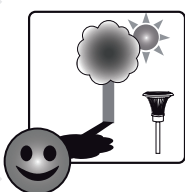
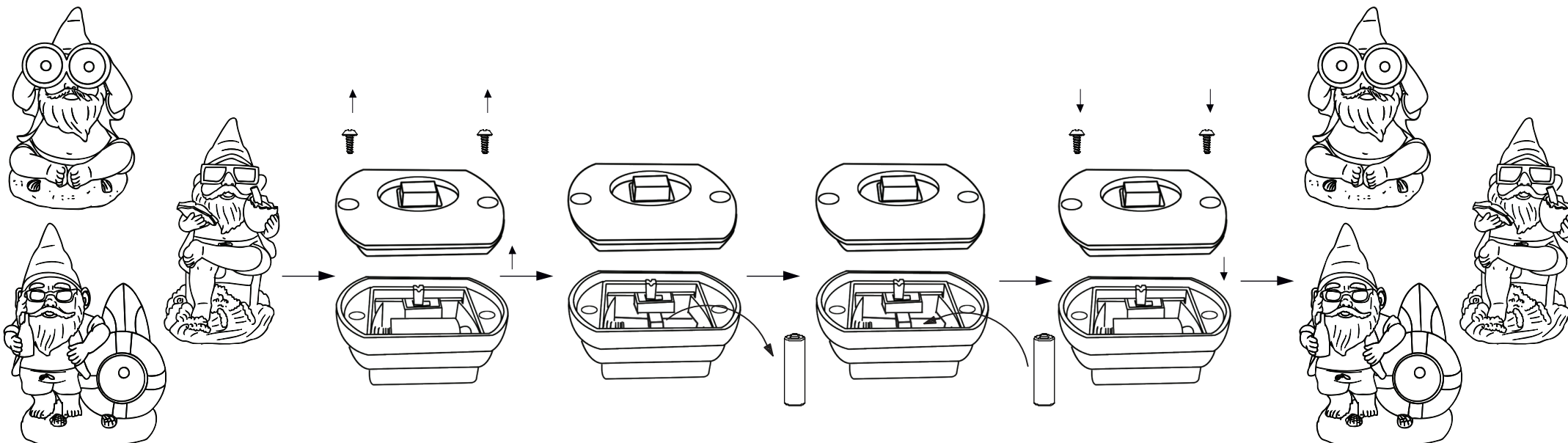

STAR[®]
TRADING
STAR STREET 1
512 50 SVENLJUNGA
SWEDEN
www.startrading.com