

Art no. 479-54

FIRST USE

STEP 1

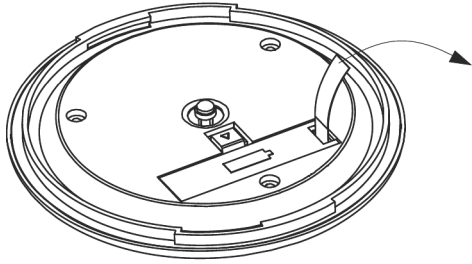

STEP 2

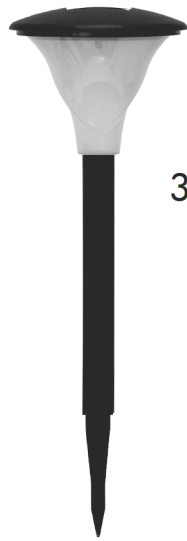

36h

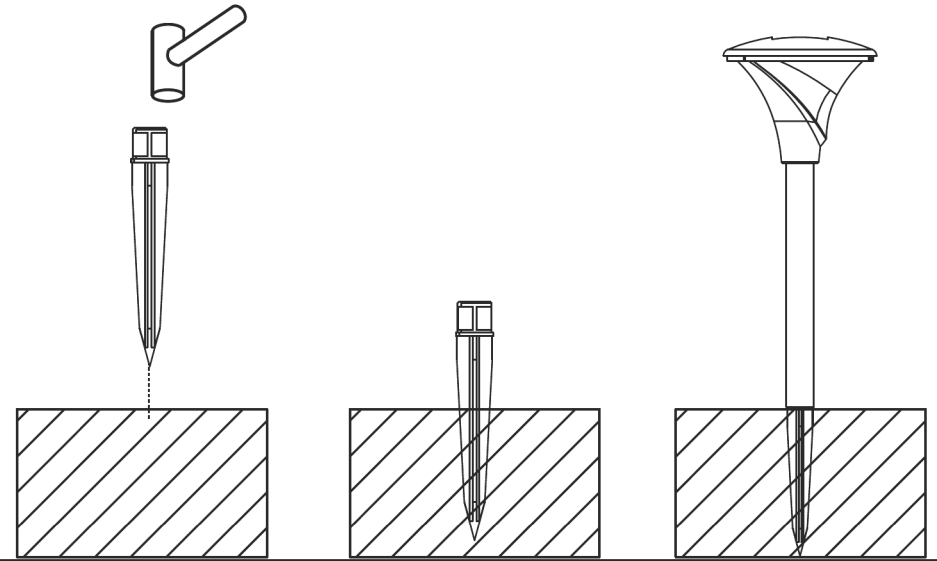

BATTERY REPLACEMENT

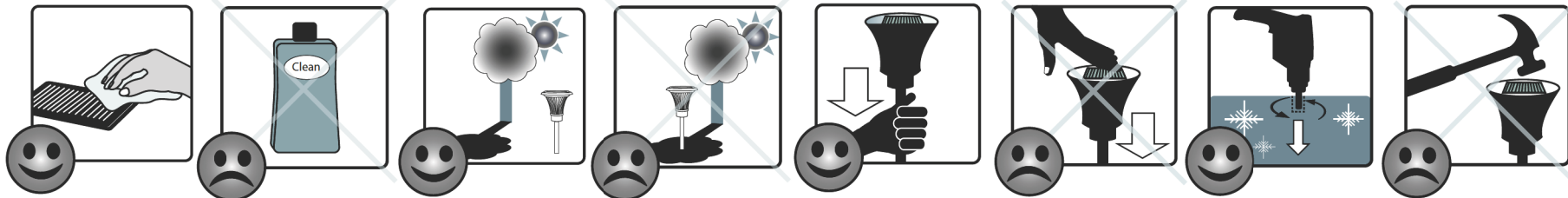
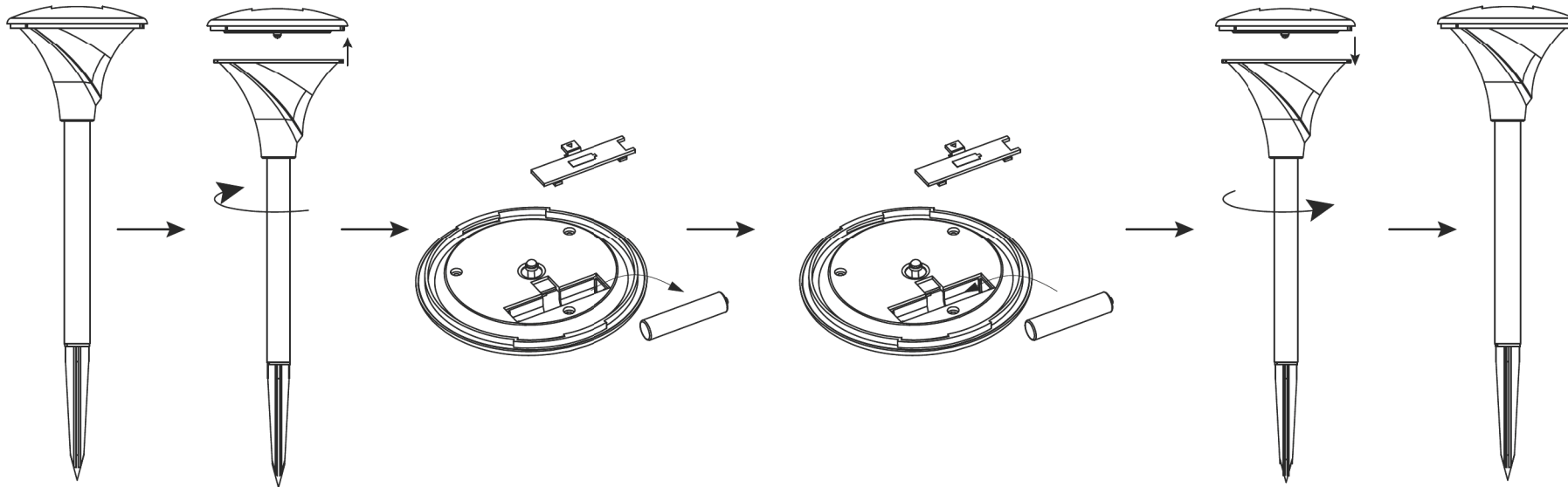

STAR
TRADING

STAR STREET 1
512 50 SVENLJUNGA
SWEDEN

Agentur für Saisonprodukte

"Best Season"

GUTENBERGSTRASSE 1
311 57 SARSTEDT
GERMANY