

Art.no 481-08

FIRST USE

STEP 1.

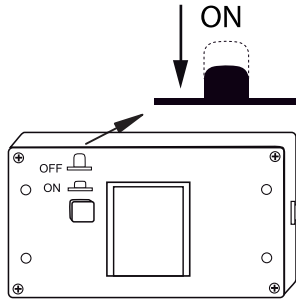

STEP 2.



Ready after  
36 h in the sun

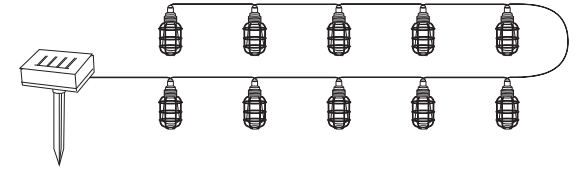

BATTERY REPLACEMENT

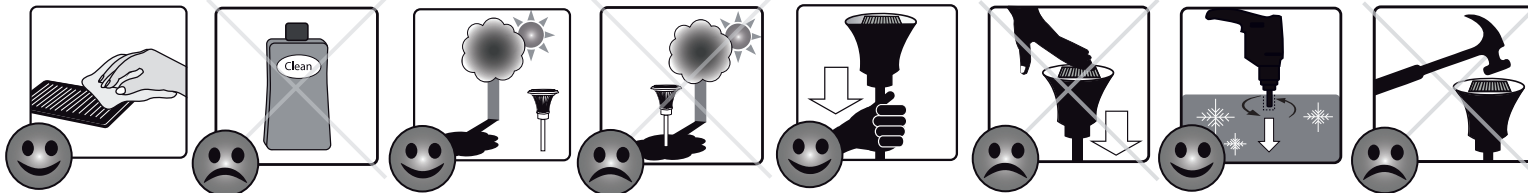
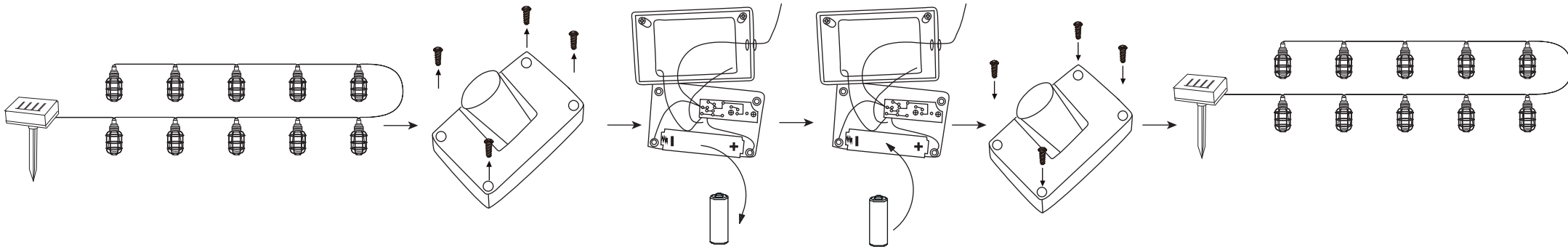

**STAR**<sup>®</sup>  
TRADING  
STAR STREET 1  
512 50 SVENLJUNGA  
SWEDEN  
[www.startrading.com](http://www.startrading.com)